

Article number: 439500360

Description: Rota-fix shaft-hub connection F360x455
Steel

Note: Self centering. Very high torque

Measures

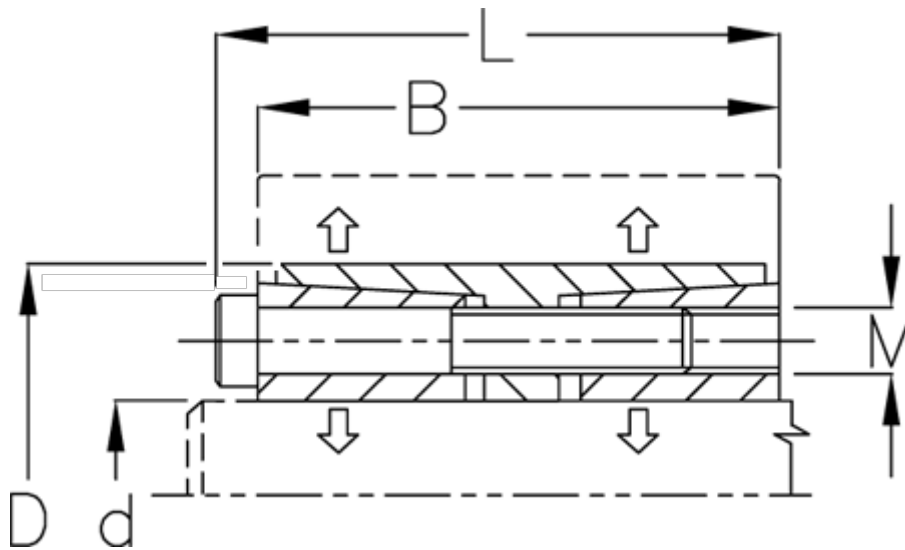

B mm	= 202
d H8 mm	= 360
D mm	= 455
Fit tolerance	= Aksel h8, Nav H8
F kN torque	= 3267.0
L mm	= 224
M mm	= M22
P N/mm ² surface pressure on shaft/hub	= 100

Surface roughness	= R? ? 3.2 µm
T N m torque	= 588000
Ts N m bolt tightening torque	= 930.0